

MENÚ by Rafa García, 2009

SANCAL



EXPLICACION DEL MODELO

Rafa García ha creado la bancada Menú con el propósito de ofrecer un diseño diferenciado y mutante, integrable en cualquier espacio.

Menú ofrece múltiples opciones en un sólo producto. Su principal virtud es su enorme capacidad de adaptación a las necesidades de cada proyecto.

Menú está diseñada para adaptarse estéticamente al resto de piezas que componen el ambiente, ya que es posible seleccionar entre diferentes acabados para el zócalo (haya tintada o tapizada), para las patas de metal (cromado o lacado negro) y para las patas de madera (haya tintada o lacada).

La adaptabilidad de esta bancada también viene dada por sus 5 bancos sin respaldo, sus 4 módulos y las 2 opciones de ángulo que ofrece para hacer rincón o esquina.

Otro aspecto que la diferencia es la posibilidad de elegir el respaldo liso o con botones.

Menú se puede tapizar tanto en tela, piel o piel sintética.

La unión entre módulos con pata de metal y pata de madera se realiza mediante carracas. Los módulos con zócalo van sueltos.

IMPORTANTE

Estructura tapizada fija, no desenfundable.
Las solicitudes de composiciones modulares deben adjuntar un plano en planta al realizar el pedido.

Por favor, no olvide indicar en el pedido el tipo de acabado deseado para el zócalo o las patas: referencia de tela, acabado del haya o del metal.

PATAS MADERA: ACABADOS Y COLORES WOODEN FEET: FINISHES AND COLOURS PIEDS EN BOIS: COULEUR

HAYA / BEECH / HÊTRE Tintes / Stains / Teinture



LACADOS / LACQUERS / LAQUES



DESCRIPTION OF THE MODEL

Rafa García created the Menú bench in order to offer a different, transforming design, which can be integrated into any space.

Menú offers multiple options within a single product. Its main virtue is its large capacity to adapt to the needs of each project.

Menú is conceived to adapt aesthetically to the remaining pieces which make up the environment, since it is possible to select between various finishes for the plinth (stained or upholstered beech), metal legs (chromed or black lacquer) and wooden legs (stained or lacquered beech).

The adaptability of this bench is also shown by its 5 benches without backs, its 4 modules and the 2 angle options it offers to make a corner.

Another differentiating aspect is the possibility of choosing either a plain back or one that includes buttons.

Menú can be upholstered in fabric, leather or synthetic leather.

Modules with metal or wooden legs can be joined by using a ratchet system. Modules with plinths are free-standing.

IMPORTANT

Fixed upholstered structure – covers not removable.
The requests for modular combinations must include a plan when making the order.

Please remember to indicate the desired type of finish for the plinth or legs on the order: fabric reference, beech or metal finish.

PATAS METAL: ACABADOS Y COLORES METAL FEET: FINISHES AND COLOURS PIEDS MÉTAL: COULEUR

METAL / METAL / MÉTAL



CARACTERISTIQUES

Rafa García a créé la banquette Menú dans le but de proposer un design différencié et mutant, intégrable dans grand nombre d'espaces.

Menú offre de multiples options dans un seul produit. Sa principale vertu est son énorme capacité d'adaptation aux nécessités de chaque projet.

Menú est dessiné pour s'adapter esthétiquement au reste des pièces qui composent le projet grâce aux nombreuses options: socle en hêtre teinté ou recouvert de tissu, pieds métal chromés ou laqués noir, pieds en hêtre teinté ou laqué.

Adaptabilité grâce à ses 5 banquettes sans dossier, ses 4 modules et ses 2 types d'angle (angle ou coin).

Le dossier peut être avec ou sans boutons (capitonné ou non).

Disponible en tissu, cuir ou cuir synthétique.

L'union des modules avec pied en bois ou métal se fait à l'aide de pièces d'union. Les modules avec socle ne sont jamais reliés.

IMPORTANT

Structure fixe non déhoussable.

Toute commande d'ensemble modulable doit être accompagnée d'un plan se lisant toujours vue de face.

Ne pas oublier non plus d'indiquer le type de finition désiré pour le socle ou les pieds: revêtement, couleur du bois ou du métal.

ZÓCALO ACABADOS Y COLORES BASE: FINISHES AND COLOURS SOCLE: COULEUR

HAYA / BEECH / HÊTRE Tintes / Stains / Teinture



CARACTERISTICAS TECNICAS

- Estructura de madera forrada en espuma HR 30kg Ultracel de 10mm de espesor.
- Bastidor de asiento preparado con tablero de partículas y espuma S/D 40kg Ultracel, recubierta de fibra de 150gr.
- Bastidor de respaldo preparado con espuma HR 35kg Ultracel recubierta de fibra de 150gr.
- Zócalo tapizado: estructura de tablero de partículas recubierta de espuma HR 30kg Ultracel y patas de PEBD (polietileno de baja densidad).
- Zócalo tintado: estructura de madera de DM chapada en haya y patas de PEBD.
- Patas de madera: madera de haya y taco anti-rozamiento de PEBD.
- Patas de metal: varilla de acero F1 de 14mm acabado cromado o pintado epoxi negro y taco anti-rozamiento de PEBD.

Los respaldos con botones tienen un incremento de precio diferente para cada medida de módulo. Para calcular el precio de las composiciones con botones, sólo hay que sumar los puntos correspondientes a la columna + BOTONES.

TECHNICAL CHARACTERISTICS

- Wooden structure with a 10mm HR 30kg Ultracel foam.
- Seat area fitted with chip board and S/D 40kg Ultracel foam, covered in 150g fibre.
- Back area fitted with HR 35kg Ultracel foam covered in 150g fibre.
- Upholstered base: chip board structure covered in HR 30kg Ultracel foam and low density polyethylene feet.
- Stained base: wooden structure of DM veneered in beech and low density polyethylene feet.
- Wooden feet: beech and anti-scratch glide of low density polyethylene.
- Metal feet: 14mm F1 steel structure, chromed finished or black epoxy coating and anti-scratch glide of low density polyethylene.

The price increase for buttoned backs depends on the measurement of the module. To calculate the price of a composition with buttons, add to each module the points shown in the following chart + BUTTONS.

CARACTERISTIQUES TECHNIQUES

- Structure en bois recouverte de mousse HR 30kg Ultracel de 10mm d'épaisseur.
- Châssis d'assise en panneau de particules et mousse S/D 40kg Ultracel, recouverte de fibre de 150gr.
- Châssis de dos recouvert de mousse HR 35kg et fibre de 150gr.
- Socle tapissé: structure en panneau de particules recouvert de mousse HR 30kg. Pieds en PEBD (polyéthylène basse densité).
- Socle en bois teinté: structure en médium plaqué hêtre et pieds en PEBD.
- Pieds bois: en hêtre et patin en PEBD.
- Pieds métal: en acier F-1 de 14mm finition chromé ou peint époxy noir, patin en PEBD.

Le supplément pour les boutons de dos est variable selon les modules. Pour calculer une composition avec boutons, il suffit de rajouter le nombre de points de la colonne + BOUTONS, à la somme de points totale.

RESPALDOS LISOS / BACKS / DOSSIER SANS BOUTONS

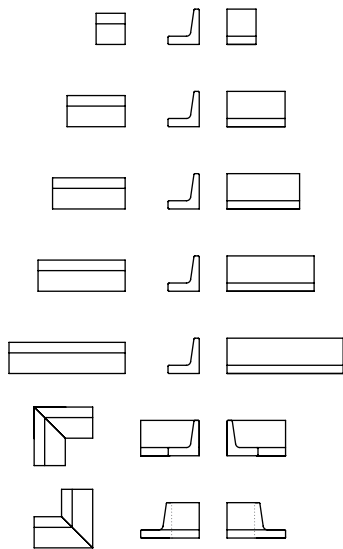

RESPALDOS CON BOTONES / BUTTONED BACKS / DOSSIER AVEC BOUTONS

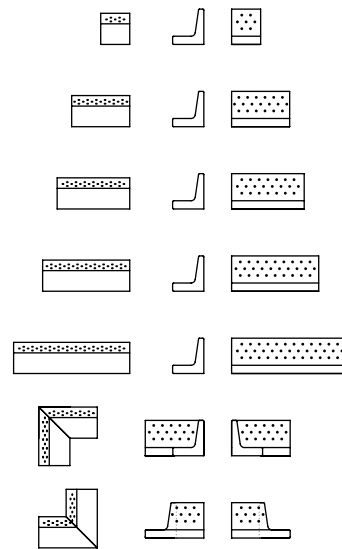

POSIBLES COMPOSICIONES / POSSIBLE COMPOSITIONS:

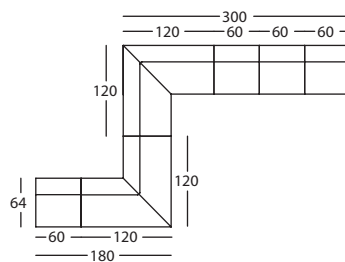

PATA MADERA
WOODEN FEET
PIED BOIS

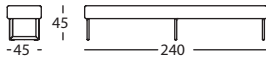
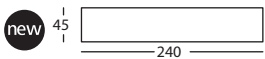
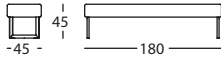
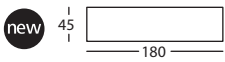
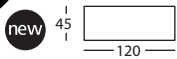
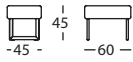

PATA METAL
METAL FEET
PIED METAL

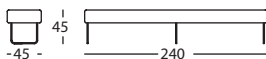
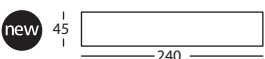
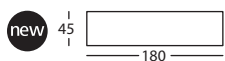
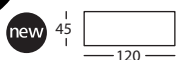
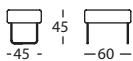

BANCO 60 PATA MADERA SIN RESP.
BENCH 60 WOODEN FEET (NO BACK)
BANQUETTE 60 PIED BOIS SANS DOSSIER **257.151.G.6**

BANCO 120 PATA MADERA SIN RESP.
BENCH 120 WOODEN FEET (NO BACK)
BANQUETTE 120 PIED BOIS SANS DOSSIER **257.151.N.6**

BANCO 150 PATA MADERA SIN RESP.
BENCH 150 WOODEN FEET (NO BACK)
BANQUETTE 150 PIED BOIS SANS DOSSIER **257.151.R.6**

BANCO 180 PATA MADERA SIN RESP.
BENCH 180 WOODEN FEET (NO BACK)
BANQUETTE 180 PIED BOIS SANS DOSSIER **257.151.U.6**

BANCO 240 PATA MADERA SIN RESP.
BENCH 240 WOODEN FEET (NO BACK)
BANQUETTE 240 PIED BOIS SANS DOSSIER **257.151.Z1.6**

BANCO 60 PATA METAL SIN RESP.
BENCH 60 METAL FEET (NO BACK)
BANQUETTE 60 PIED METAL SANS DOSSIER **257.151.G.7**

BANCO 120 PATA METAL SIN RESP.
BENCH 120 METAL FEET (NO BACK)
BANQUETTE 120 PIED METAL SANS DOSSIER **257.151.N.7**

BANCO 150 PATA METAL SIN RESP.
BENCH 150 METAL FEET (NO BACK)
BANQUETTE 150 PIED METAL SANS DOSSIER **257.151.R.7**

BANCO 180 PATA METAL SIN RESP.
BENCH 180 METAL FEET (NO BACK)
BANQUETTE 180 PIED METAL SANS DOSSIER **257.151.U.7**

BANCO 240 PATA METAL SIN RESP.
BENCH 240 METAL FEET (NO BACK)
BANQUETTE 240 PIED METAL SANS DOSSIER **257.151.Z1.7**

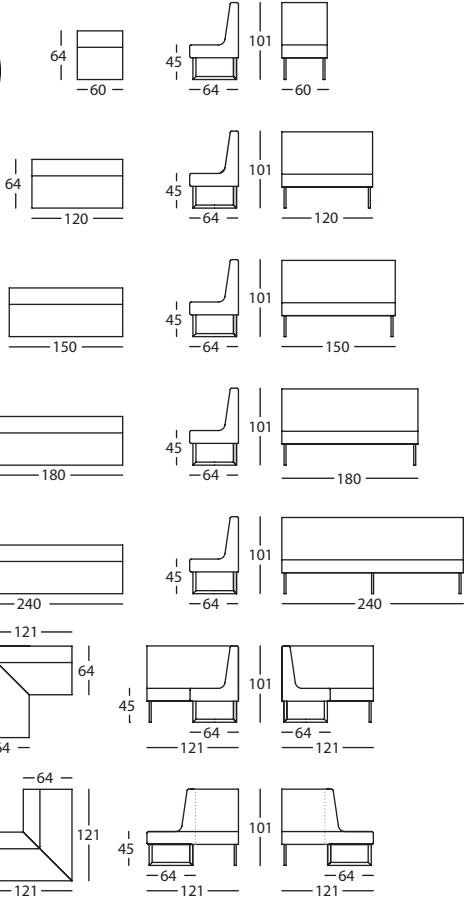

MOD 60 PATA MADERA
MOD 60 WOODEN FEET
MOD 60 PIED BOIS **257.121.G.6**

MOD 120 PATA MADERA
MOD 120 WOODEN FEET
MOD 120 PIED BOIS **257.121.N.6**

MOD 150 PATA MADERA
MOD 150 WOODEN FEET
MOD 150 PIED BOIS **257.121.R.6**

MOD 180 PATA MADERA
MOD 180 WOODEN FEET
MOD 180 PIED BOIS **257.121.U.6**

MOD 240 PATA MADERA
MOD 240 WOODEN FEET
MOD 240 PIED BOIS **257.121.Z1.6**

ANGULO 90° PATA MADERA
CORNER 90° WOODEN FEET
ANGLE 90° PIED BOIS **257.161.6**

ANGULO 270° PATA MADERA
CORNER 270° WOODEN FEET
ANGLE 270° PIED BOIS **257.164.6**

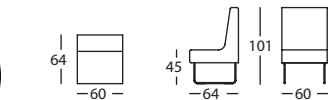

MOD 60 PATA METAL
MOD 60 METAL FEET
MOD 60 PIED METAL **257.121.G.7**

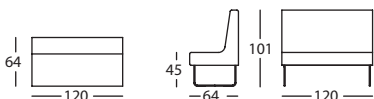

MOD 120 PATA METAL
MOD 120 METAL FEET
MOD 120 PIED METAL **257.121.N.7**

new

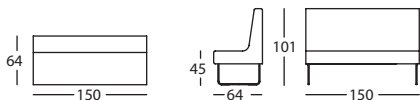

MOD 150 PATA METAL
MOD 150 METAL FEET
MOD 150 PIED METAL **257.121.R.7**

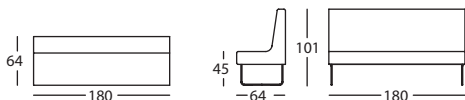

MOD 180 PATA METAL
MOD 180 METAL FEET
MOD 180 PIED METAL **257.121.U.7**

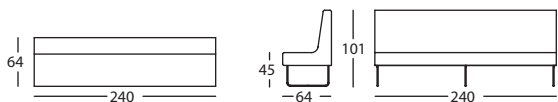

MOD 240 PATA METAL
MOD 240 METAL FEET
MOD 240 PIED METAL **257.121.Z1.7**

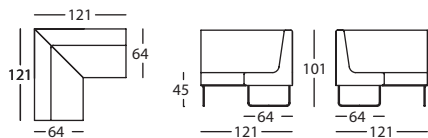

ANGULO 90° PATA METAL
CORNER 90° METAL FEET
ANGLE 90° PIED METAL **257.161.7**

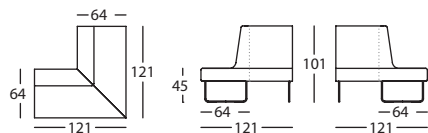

ANGULO 270° PATA METAL
CORNER 270° METAL FEET
ANGLE 270° PIED METAL **257.164.7**

ZOCALO
MADERA
WOODEN BASE
SOCLE BOIS

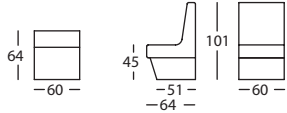

MOD 60 ZOCALO MADERA
MOD 60 WOODEN BASE
MOD 60 SOCLE BOIS **257.121.G.Z6**

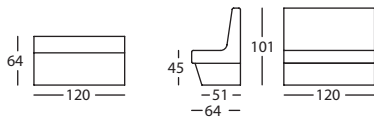

MOD 120 ZOCALO MADERA
MOD 120 WOODEN BASE
MOD 120 SOCLE BOIS **257.121.N.Z6**

new

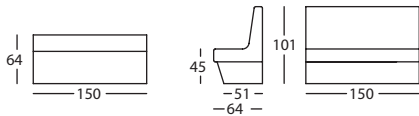

MOD 150 ZOCALO MADERA
MOD 150 WOODEN BASE
MOD 150 SOCLE BOIS **257.121.R.Z6**

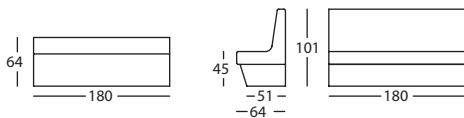

MOD 180 ZOCALO MADERA
MOD 180 WOODEN BASE
MOD 180 SOCLE BOIS **257.121.U.Z6**

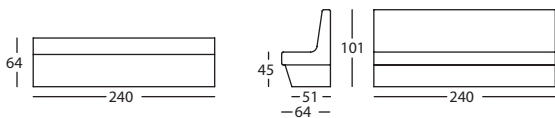

MOD 240 ZOCALO MADERA
MOD 240 WOODEN BASE
MOD 240 SOCLE BOIS **257.121.Z1.Z6**

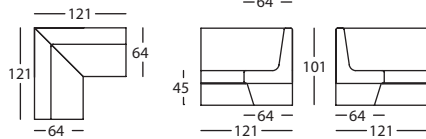

ANGULO 90° ZOCALO MADERA
CORNER 90° WOODEN BASE
ANGLE 90° SOCLE BOIS **257.161.Z6**

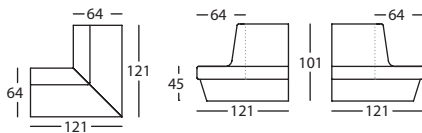

ANGULO 270° ZOCALO MADERA
CORNER 270° WOODEN BASE
ANGLE 270° SOCLE BOIS **257.164.Z6**

ZOCALO
TAPIZADO
UPHOLSTERED
BASE
SOCLE
TAPISEE

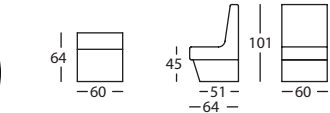

MOD 60 ZOCALO TAPIZADO
MOD 60 UPHOLSTERED BASE
MOD 60 SOCLE TAPISEE **257.121.G.ZT**

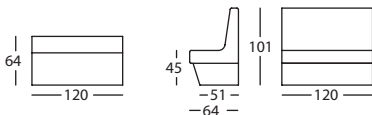

MOD 120 ZOCALO TAPIZADO
MOD 120 UPHOLSTERED BASE
MOD 120 SOCLE TAPISEE **257.121.N.ZT**

new

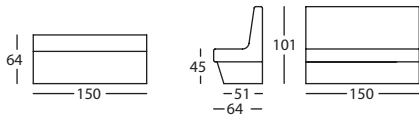

MOD 150 ZOCALO TAPIZADO
MOD 150 UPHOLSTERED BASE
MOD 150 SOCLE TAPISEE **257.121.R.ZT**

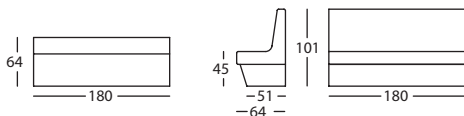

MOD 180 ZOCALO TAPIZADO
MOD 180 UPHOLSTERED BASE
MOD 180 SOCLE TAPISEE **257.121.U.ZT**

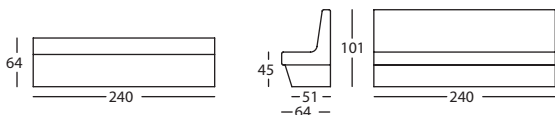

MOD 240 ZOCALO TAPIZADO
MOD 240 UPHOLSTERED BASE
MOD 240 SOCLE TAPISEE **257.121.Z1.ZT**

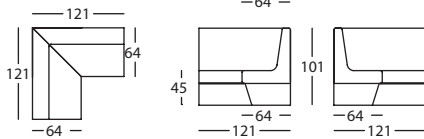

ANGULO 90° ZOCALO TAPIZADO
CORNER 90° UPHOLSTERED BASE
ANGLE 90° SOCLE TAPISEE **257.161.ZT**

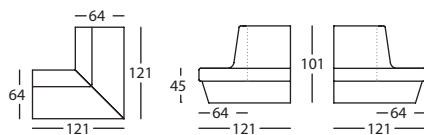

ANGULO 270° ZOCALO TAPIZADO
CORNER 270° UPHOLSTERED BASE
ANGLE 270° SOCLE TAPISEE **257.164.ZT**